

PLAN CADASTRAL
UAT ROSIORI JUDETUL BACAU
Sectorul cadastral 34
Scara 1:1000

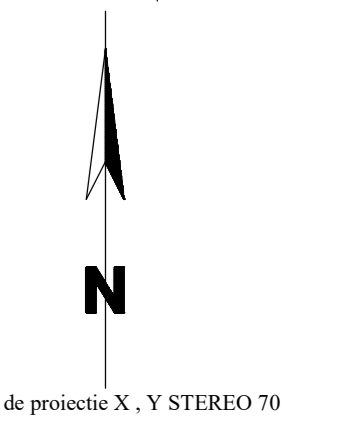

Sistem de proiect X, Y STEREO 70

Legenda :

Numarul sectorului : **1**

Cadru plansa
Limita de judet
Limita UAT
Limita sectoare cadastrale
Limita intravilan
Limita imobil
Limita constructiilor cu caracter permanent

Hydrografie

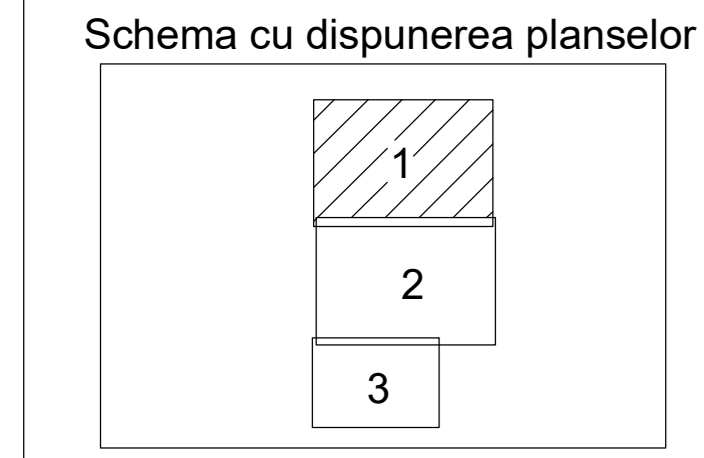

Rosiori

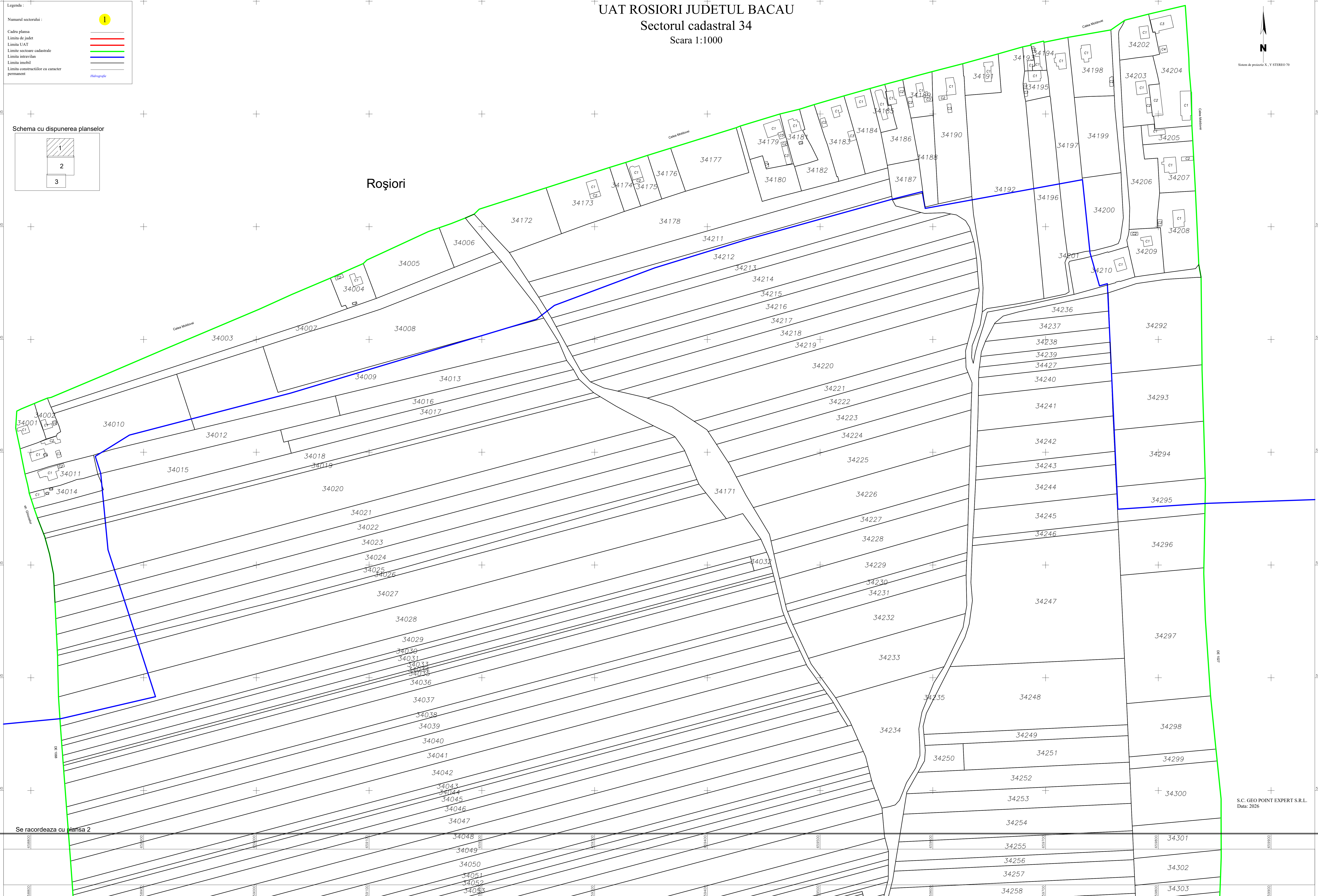

Se racordeaza cu plansa 2

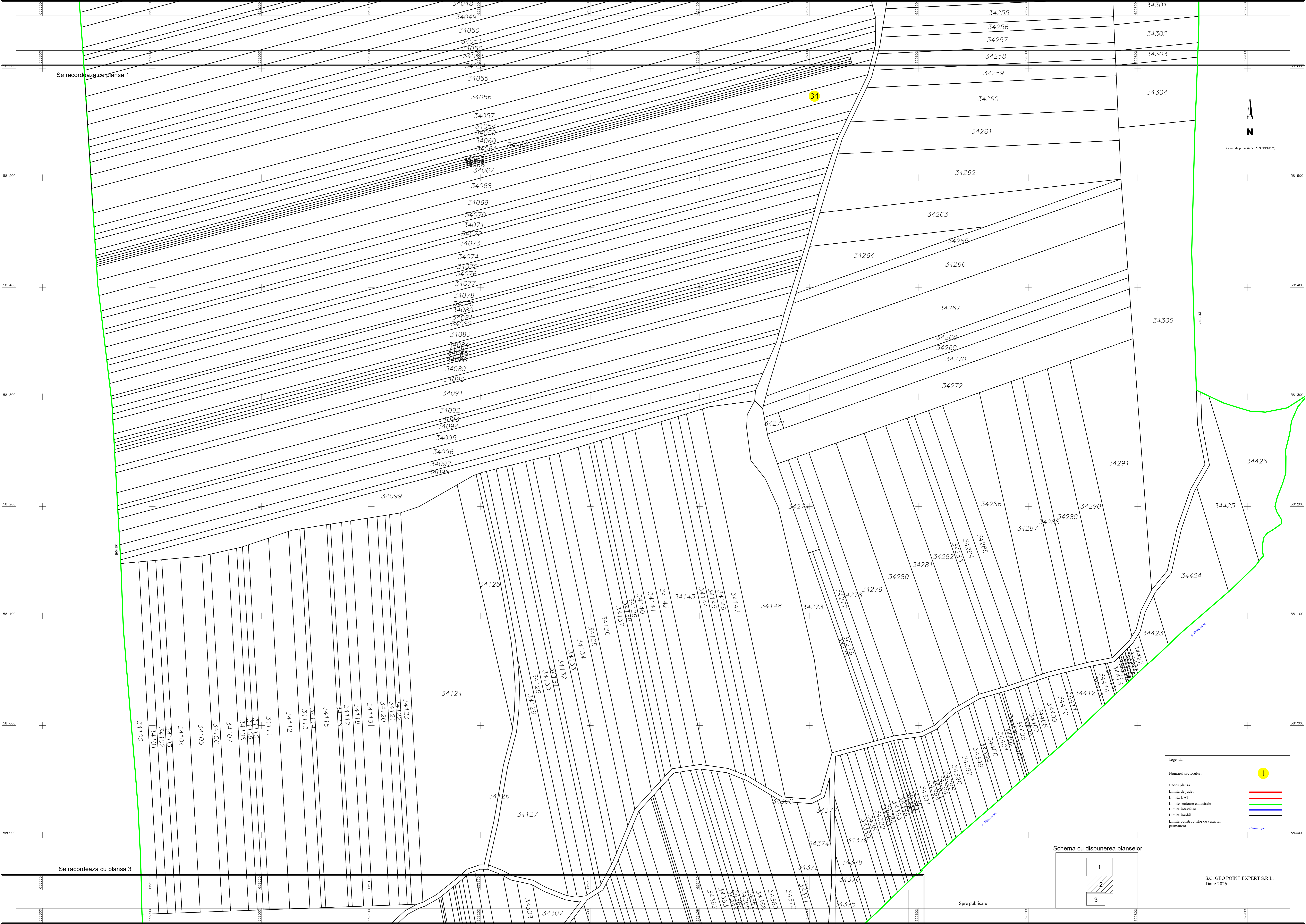

Se racordeaza cu plansa 1

Se racordeaza cu plansa 3

34

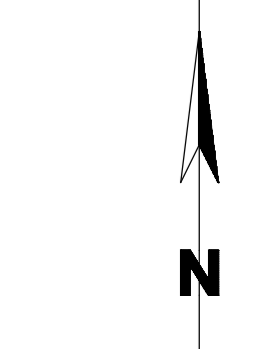

Sistem de proiect X, Y STEREO 70

Legenda :

Numarul sectorului :	1
Cadru plansa	—
Limita de județ	—
Limita UAT	—
Limita sectoare cadastrale	—
Limita intravilan	—
Limita imobil	—
Limita construcțiilor cu caracter permanent	—

Schema cu dispunerea planselor

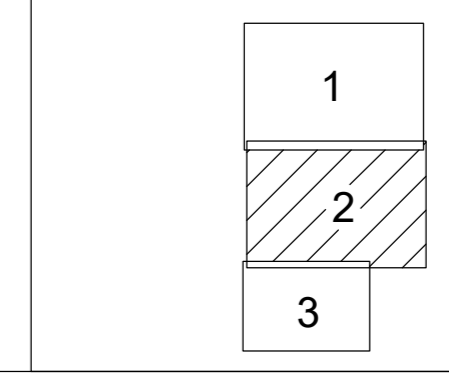

Spre publicare

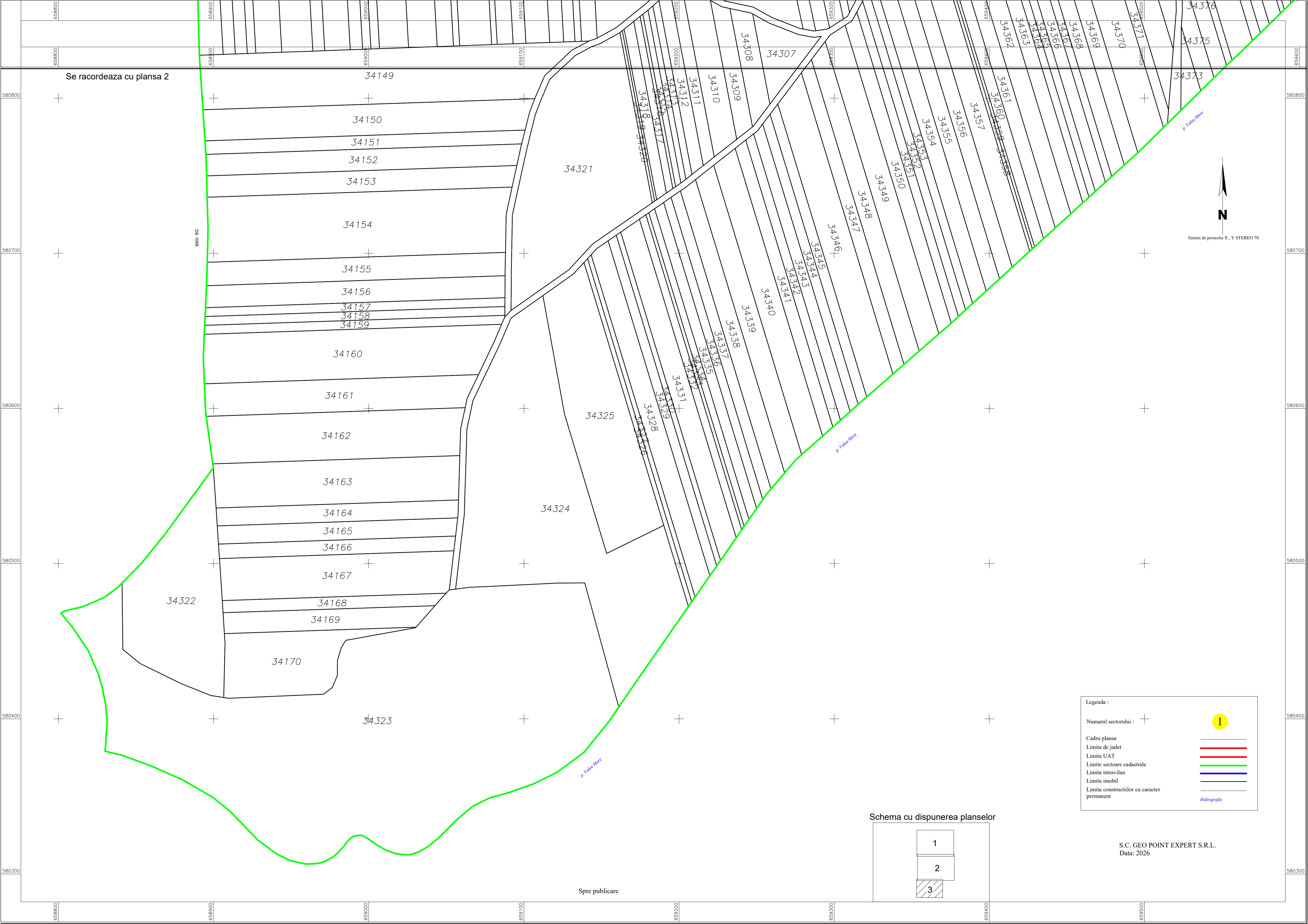

Se racordeaza cu plansa 2

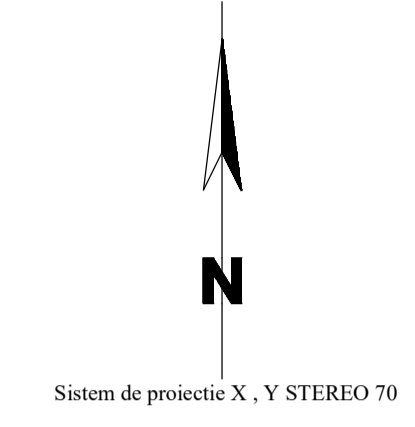

Legenda :

Numarul sectorului :	+	1
Cadru plansa	—	
Limita de judet	—	
Limita UAT	—	
Limite sectoare cadastrale	—	
Limita intravilan	—	
Limita imobil	—	
Limita constructiilor cu caracter permanent	—	
		Hydrografie

Schema cu dispunerea planselor

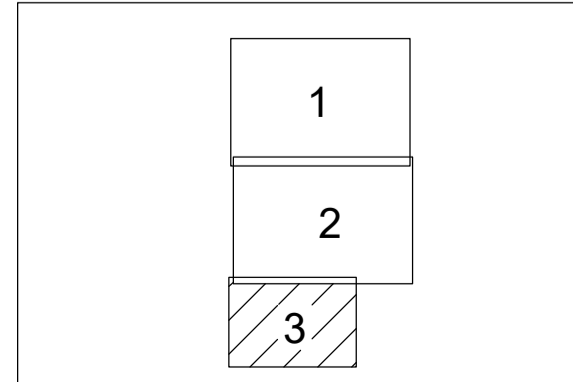

S.C. GEO POINT EXPERT S.R.L.
Data: 2026

Spre publicare